

(Not to scale)

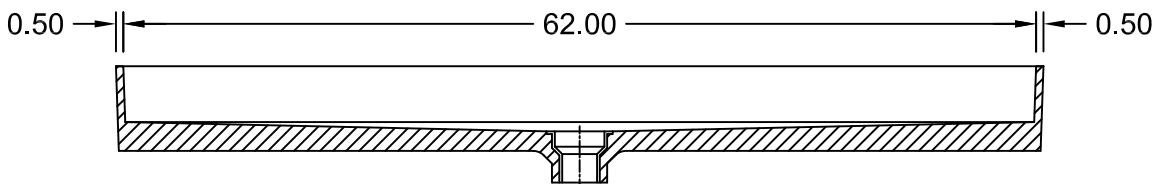

SECTION A-A

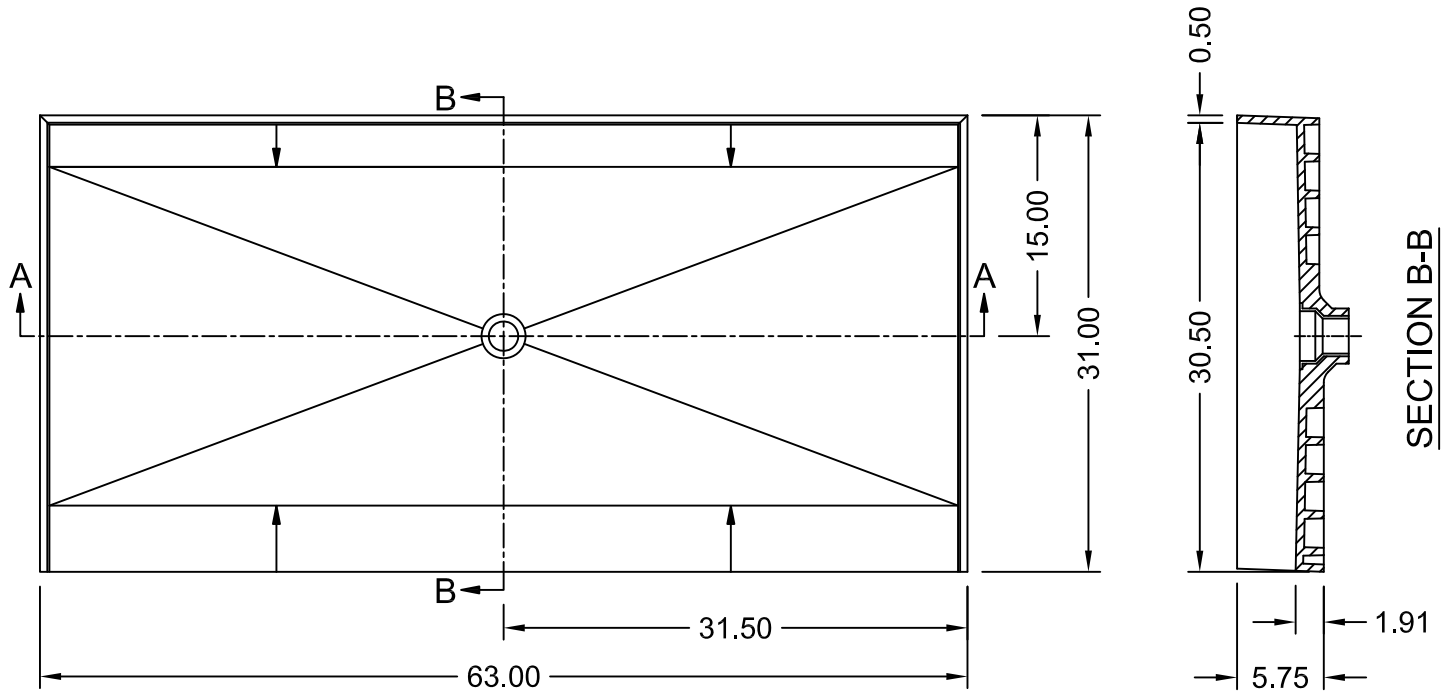

ANSI Z124.1-95
ANSI Z124.2-95
ICC/ANSI A117.1.98

ASTM F462-79
B45.0-02
B45.5-02

Toll Free 800.232.6156 techsupport@tileredi.com
Tel: 954.323.0125
Fax: 954.344.8064 www.tileredi.com



V.2013.01.29