

(Not to scale)

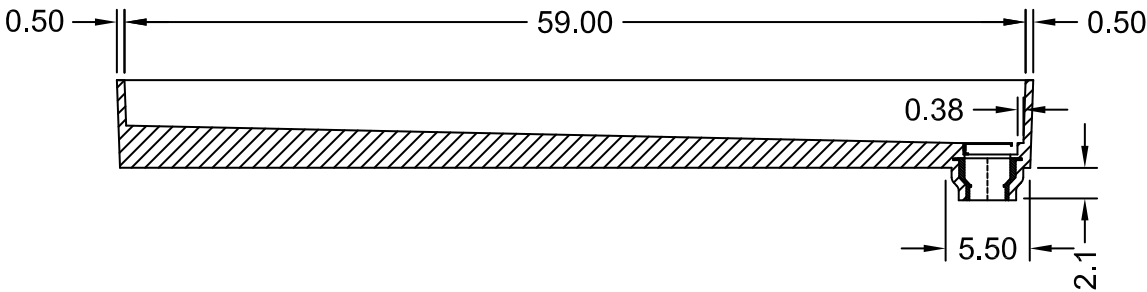

SECTION A-A

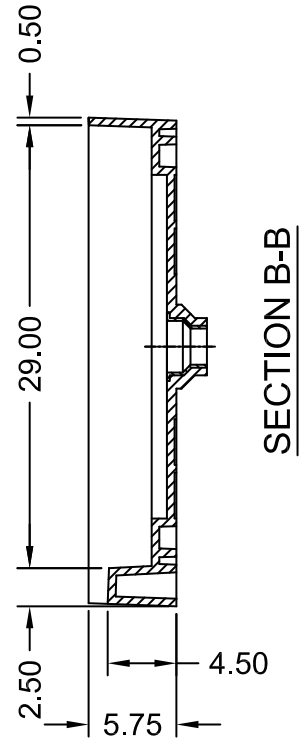
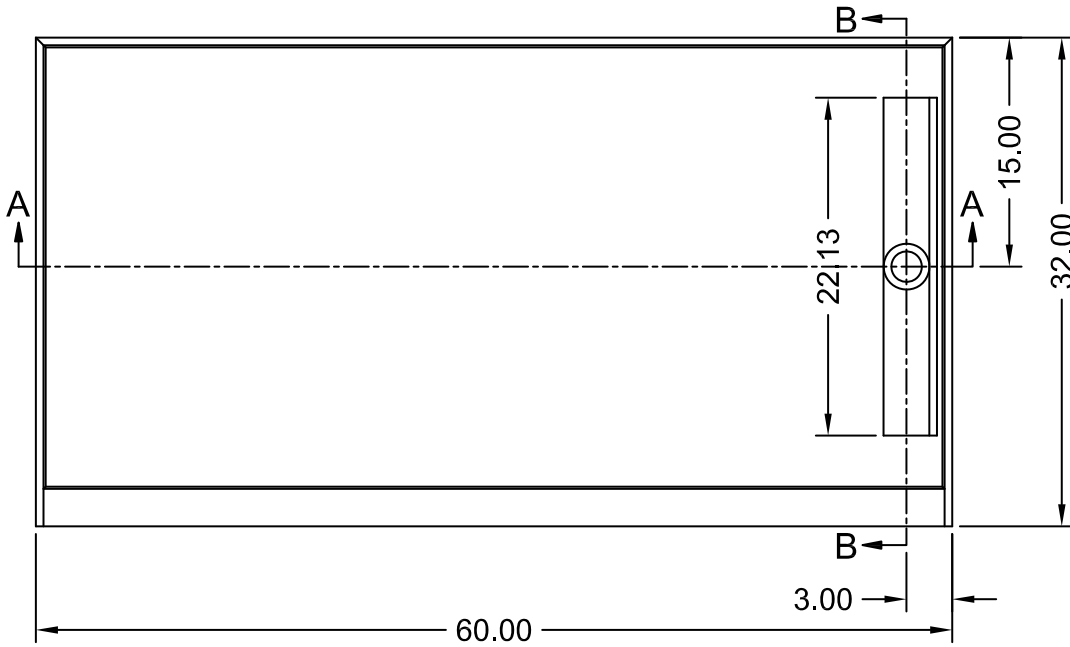

ANSI Z124.1-95 ASTM F462-79
ANSI Z124.2-95 B45.0-02
ICC/ANSI A117.1.98 B45.5-02

Toll Free: 800.232.6156
Tel: 954.323.0125
Fax: 954.344.8064

techsupport@tileredi.com
www.tileredi.com



2023.06.08